

PART NUMBER
SSA54.5



SCAN HERE: To watch a video of this installation



BEFORE YOU BEGIN

PRIMARY APPLICATIONS

- > Chevrolet Silverado 4500 4 X 2 & 4 X 4 (2019 - present)
- > Chevrolet Silverado 5500 4 X 2 & 4 X 4 (2019 - present)
- > Chevrolet Silverado 6500 4 X 2 & 4 X 4 (2019 - present)
- > GMC Sierra 4500 4 X 2 & 4 X 4 (2019 - present)
- > GMC Sierra 5500 4 X 2 & 4 X 4 (2019 - present)
- > GMC Sierra 6500 4 X 2 & 4 X 4 (2019 - present)
- > International CV 4 X 2 & 4 X 4 (2019 - present)

PARTS LIST

Item	Part #	Description	QTY
A	102054	SSA54 Leaf Spring	2
B	112240	Square U-Bolt 8 1/2" Long	1
C	112285	U-Bolt Clip	2
D	512097	Spacer Plate	2
E	112253	Spring Clamp Plate	2
F	512204	3/4" Flat Washer	4
G	512365	3/4-16 High Nut	4
H	112238	Square U-Bolt 7 1/2" Long	1

TOOLS REQUIRED

- > Floor Jack
- > Safety Jack Stands
- > Wheel Chocks
- > 1-1/8" Wrench/Socket
- > Torque Wrench

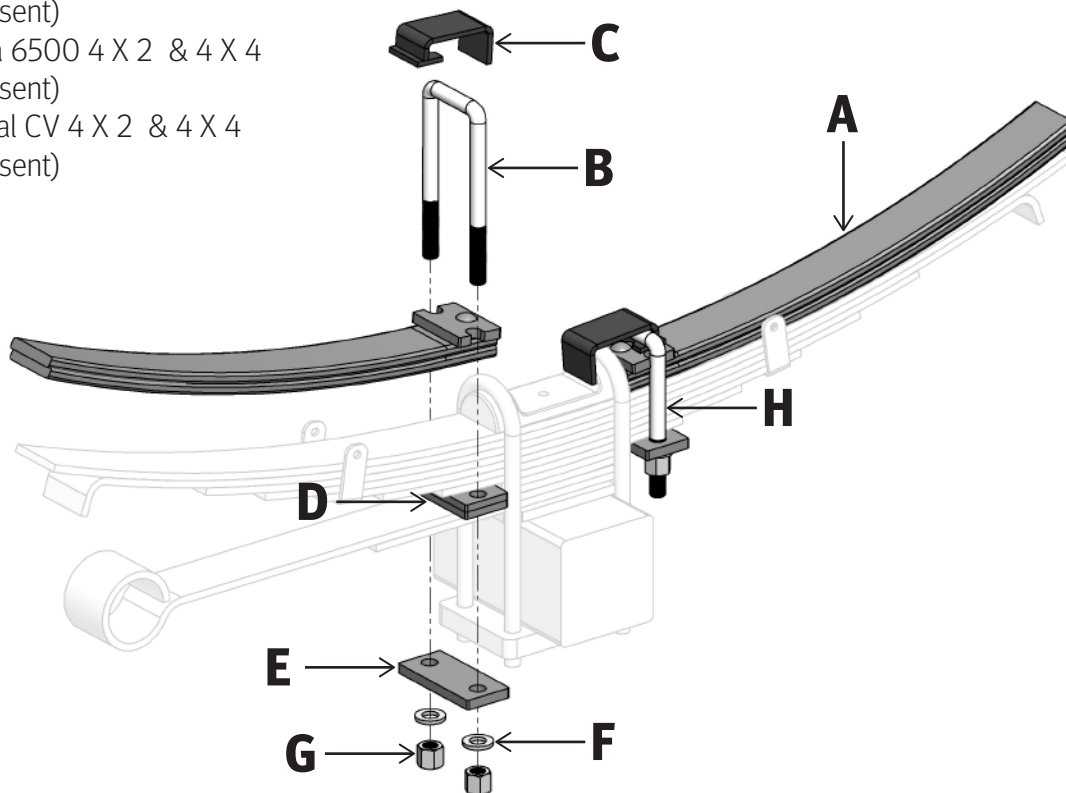

Part Number: SSA54.5

Product Line: SUPERSPRINGS

Page 1

Questions or Concerns?

Scan here:



or visit:
superspringsinternational.com

SAFETY NOTICE: We recommend installation be done by a professional or persons with sound mechanical knowledge.

WARNING: These instructions are a general guide for installation. SuperSprings International (SSI) assumes no liability for the actual installation process. Consumers and installers should apply common automotive safety practices when raising and working on any vehicle. **Do not put yourself in a position where, if the vehicle were to move unexpectedly, you may be injured.** SSI's products are designed to improve vehicle ride quality. Do not load any vehicle beyond the manufacturer's specifications.

Never exceed the manufacturer's Gross Vehicle Rating (GVWR) located on your vehicles identification tag.

BEFORE INSTALLATION: Ensure the vehicle is on a hard level surface, the parking brake is ON, with the ignition OFF, and place chocks in front of and behind the tires to prevent the vehicle from moving.

DURING AND/OR AFTER INSTALLATION: Ensure emergency brake cables are not touching the SSI products. Secure any cables out of the way with zip ties or by re-routing. Ensure all A/C lines, brake cables, and frame are clear of contact or interference.

REV. 1.01 | OCT 2023

PART NUMBER

SSA54.5



INSTALLATION

1. Positioning the vehicle – Vehicle must be on level solid surface. Ensure emergency brake is ON and Ignition is OFF. Place chocks in front and rear of the front tires to prevent the vehicle from moving.
2. Jacking up vehicle – Jack up the vehicle and support the frame with jack stands so that the axle is hanging with tires slightly off the ground and the leaf springs are separated from the spring perch. You may remove the wheel for easier installation access but it is not required.
3. Remove the bolts and sleeves from O.E. spring clips – Using a wrench or cutting tool, remove the bolts and spacer sleeve located above the leaf pack in the O.E. spring clips. Leave the spring clips in place. [IMAGE 1]
4. Placement of the front SuperSprings – Place one of the SuperSprings on top of the front half of the leaf pack with the end behind the front spring perch. Slide the end through the perch until the spring can lay flat on the top leaf of the O.E. spring pack. Slide the SuperSprings back until it is against the u-bolt plate. [IMAGE 2 & 3]
5. Use of Spacer Plates [ITEM D]: Refer to diagram for placement. If your leaf pack has a gap above the locating leaf, position one or two of the Spacer plates in that location to fill the void between the locating leaf and the main leaf pack. If no gap is present, the the Spacer Plates will not be used.
6. Install U-bolts – Place the supplied 8 ½" U-Bolt [ITEM B], with the threads facing down, over the clamp plate that is riveted to the top of the SuperSprings. Slide the ends through the holes of the spacer plates (if used) and allow threaded ends to hang down below the bottom of the O.E. leaf pack. Do not push the top of the u-bolt all the way down to the SuperSprings, leave about a 1" gap.
7. Install the U-bolt Clip – Insert the flat end of the U-Bolt Clip [ITEM C] under the top of the u-bolt and position the other end over the factory u-bolt and spring plate. [IMAGE 4] Push the u-bolt the rest of the way down so the clip is clamped between the u-bolt and the top of the SuperSprings.
8. Fasten lower cross plate – Place a Clamp Plate [ITEM E] over the ends of the u-bolt and slide up to contact the bottom of the leaf pack. Place one ¾" Flat Washer [ITEM F] and one ¾" Nut [ITEM G] over each leg of the u-bolt and tighten until snug.
9. Torque u-bolt nuts – Ensure that the nuts are tightened evenly and torque to 250 ft. lbs. in 3 stages.

Part Number: SSA54.5

Product Line: SUPERSPRINGS

Page 2

Questions or Concerns?

Scan here:



or visit:
superspringsinternational.com

SAFETY NOTICE: We recommend installation be done by a professional or persons with sound mechanical knowledge.

WARNING: These instructions are a general guide for installation. SuperSprings International (SSI) assumes no liability for the actual installation process. Consumers and installers should apply common automotive safety practices when raising and working on any vehicle. **Do not put yourself in a position where, if the vehicle were to move unexpectedly, you may be injured.** SSI's products are designed to improve vehicle ride quality. Do not load any vehicle beyond the manufacturer's specifications.

Never exceed the manufacturer's Gross Vehicle Rating (GVWR) located on your vehicles identification tag.

BEFORE INSTALLATION: Ensure the vehicle is on a hard level surface, the parking brake is ON, with the ignition OFF, and place chocks in front of and behind the tires to prevent the vehicle from moving.

DURING AND/OR AFTER INSTALLATION: Ensure emergency brake cables are not touching the SSI products. Secure any cables out of the way with zip ties or by re-routing. Ensure all A/C lines, brake cables, and frame are clear of contact or interference.

REV. 1.01 | OCT 2023

PART NUMBER

SSA54.5



INSTALLATION

10. Placement of the rear spring – Place one of the SuperSprings Half Leaf [ITEM A] on top of the rear half of the leaf pack with the end in front of the rear spring perch. Slide the end through the perch until the spring can lay flat on the top leaf of the O.E. spring pack. Slide the SuperSprings back until it is against the u-bolt plate.
11. Install U-bolts – Place the supplied 7 ½" U-Bolt [ITEM H], with the threads facing down, over the clamp plate that is riveted to the top of the SuperSprings and allow threaded ends to hang down below the bottom of the O.E. leaf pack.
12. Fasten lower cross plate – Place a Clamp Plate [ITEM E] over the ends of the u-bolt and slide up to contact the bottom of the leaf pack. Place one ¾" Flat Washer [ITEM F] and one ¾" Nut [ITEM G] over each leg of the u-bolt and tighten until snug.
13. Torque u-bolt nuts – Ensure that the nuts are tightened evenly and torque to 250 ft. lbs. in 3 stages.
14. Lower the vehicle – Jack up the vehicle, remove the jack stands, then lower the vehicle to the ground. Remove the chocks from front and rear of the front wheels.
15. Final Check – Check that the position of the SuperSprings ensures there is sufficient clearance to prevent any contact with frame or other components both horizontally and vertically. Also ensure that no contact will occur at max travel conditions.
16. Register the warranty for your SuperSprings International part. A warranty card can be found in the box your part came in.

Part Number: SSA54.5

Product Line: SUPERSPRINGS

Page 3

Questions or Concerns?

Scan here:



or visit:
superspringsinternational.com

SAFETY NOTICE: We recommend installation be done by a professional or persons with sound mechanical knowledge.

WARNING: These instructions are a general guide for installation. SuperSprings International (SSI) assumes no liability for the actual installation process. Consumers and installers should apply common automotive safety practices when raising and working on any vehicle. **Do not put yourself in a position where, if the vehicle were to move unexpectedly, you may be injured.** SSI's products are designed to improve vehicle ride quality. Do not load any vehicle beyond the manufacturer's specifications.

Never exceed the manufacturer's Gross Vehicle Rating (GVWR) located on your vehicles identification tag.

BEFORE INSTALLATION: Ensure the vehicle is on a hard level surface, the parking brake is ON, with the ignition OFF, and place chocks in front of and behind the tires to prevent the vehicle from moving.

DURING AND/OR AFTER INSTALLATION: Ensure emergency brake cables are not touching the SSI products. Secure any cables out of the way with zip ties or by re-routing. Ensure all A/C lines, brake cables, and frame are clear of contact or interference.

REV. 1.01 | OCT 2023

PART NUMBER
SSA54.5



INSTALLATION IMAGES

IMAGE 1



IMAGE 2



IMAGE 3



IMAGE 4



Part Number: SSA54.5

Product Line: SUPERSPRINGS

Page 4

Questions or Concerns?

Scan here:



or visit:
superspringsinternational.com

SAFETY NOTICE: We recommend installation be done by a professional or persons with sound mechanical knowledge.

WARNING: These instructions are a general guide for installation. SuperSprings International (SSI) assumes no liability for the actual installation process. Consumers and installers should apply common automotive safety practices when raising and working on any vehicle. **Do not put yourself in a position where, if the vehicle were to move unexpectedly, you may be injured.** SSI's products are designed to improve vehicle ride quality. Do not load any vehicle beyond the manufacturer's specifications.

Never exceed the manufacturer's Gross Vehicle Rating (GVWR) located on your vehicles identification tag.

BEFORE INSTALLATION: Ensure the vehicle is on a hard level surface, the parking brake is ON, with the ignition OFF, and place chocks in front of and behind the tires to prevent the vehicle from moving.

DURING AND/OR AFTER INSTALLATION: Ensure emergency brake cables are not touching the SSI products. Secure any cables out of the way with zip ties or by re-routing. Ensure all A/C lines, brake cables, and frame are clear of contact or interference.

REV. 1.01 | OCT 2023